

## UTILITY SERIES

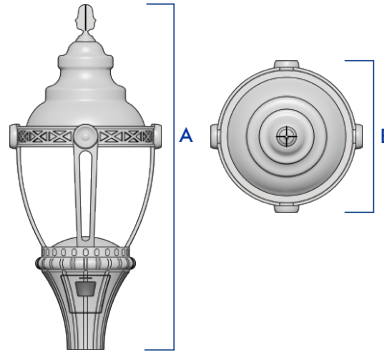

### FIXTURE DIMENSIONS



FIXTURE	A	B
UTL	42"	18.5"

### FITTER OPTIONS

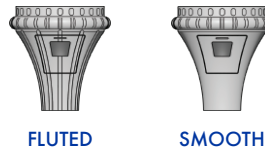

### DESCRIPTION

An outstanding traditional design and authentic appearance that is suitable for a variety of lighting applications. The UTL by AV Poles and Lighting is ideal for commercial, municipal, and design build lighting applications.







### FEATURES

- Cast aluminum construction
- Stainless steel hardware
- Dark sky/full cutoff
- 0-10V dimmable driver
- 10-20KV surge protection
- IP67 rated modules - 5 year warranty
- Up to 130+ Lumens Per Watt output
- Low maintenance cost with lifetime >54,000 hrs
- Field-rotatable modules have multiple lighting distribution options with optical lens transmittance up to 96%
- Vandal resistant silicone molded optic won't turn brittle or yellow over time, and is heat resistant up to 200°C.
- TGIC thermoset polyester powder coat finish is electrostatically applied at a 3.0 mil nominal thickness. A five stage metal pre-treatment process and sealer provide maximum corrosion resistance. The powder top coat is baked in excess of 400 degrees for supreme endurance.



## ORDERING INFORMATION

AVPL -

LUMINAIRE	OPTICS	WATTAGE	COLOR TEMP	VOLTAGE	FITTER	MOUNTING	FINISH	OPTIONS
UTL	TYPE II 	4Q1-700mA (35W)	3000K WARM WHITE	120-277V VOLTAGE SENSING	FLUTED UTL	PT23 Ø2.375" TENON	DARK BRONZE	PF FINIAL
	TYPE III 	4Q1-1050mA (55W)	4000K NEUTRAL WHITE	347-480V VOLTAGE SENSING	SMOOTH UTL	PT27 Ø2.875" TENON	BLACK	HOUSE-SIDE SHIELD
	TYPE III HSS 	4Q2-700mA (70W)	5000K COOL WHITE	PT30 Ø3" TENON		WHITE	FSP311 MOTION SENSOR	
	TYPE IV 	4Q2-1050mA (110W)				GREY	3PIN RECEPTACLE	
	TYPE IV HSS 					GREEN	7PIN RECEPTACLE	
TYPE V 								

CONTACT FACTORY FOR OTHER SIZES

ALL RAL COLORS AVAILABLE

## LUMEN OUTPUT CHART

3000K	3000K				4000K	4000K				5000K	5000K						
	Type II	Type III	Type IV	Type V		Type II	Type III	Type IV	Type V		Type II	Type III	Type IV	Type V			
	35W 700mA	4,169	4,295	4,129		4,177	35W 700mA	4,424	4,558		4,381	4,432	35W 700mA	4,496	4,632	4,452	4,504
	55W 1050mA	5,670	5,842	5,615		5,680	55W 1050mA	6,017	6,199		5,958	6,028	55W 1050mA	6,114	6,300	6,055	6,125
	70W 700mA	8,338	8,591	8,257		8,353	70W 700mA	8,848	9,116		8,762	8,864	70W 700mA	8,992	9,264	8,904	9,008
110W 1050mA	11,340	11,683	11,230	11,360	110W 1050mA	12,033	12,398	11,916	12,055	110W 1050mA	12,229	12,599	12,110	12,251			